

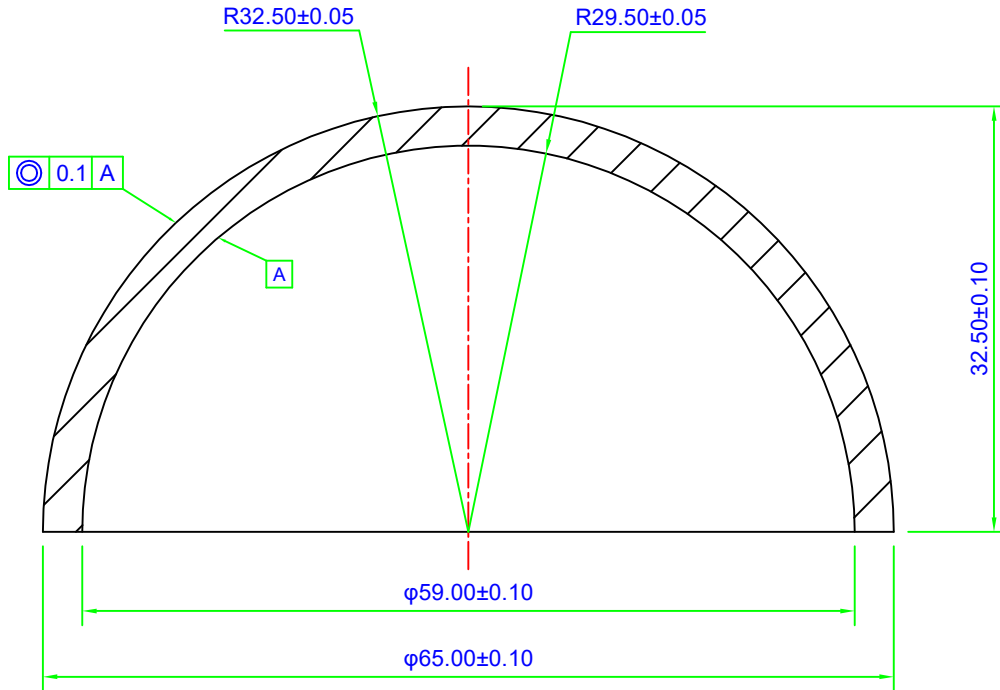







REVISIONS			
LTR	ECD	DATE	APPROVED

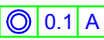

SURFACE 1	MATERIAL	SURFACE 2
R = 32.50 ±0.05mm 3/ 10(5)  4/  5/ 60-40 Chamfer: 0.2-0.5mm ×45°	H-K9L (CDGM) nd=1.51680 vd=64.20  0/ 1/ 2/ 6/	R = 29.50 ±0.05mm 3/ 10(5)  4/  5/ 60-40 Chamfer: 0.2-0.5mm ×45°

PROTECTIVE CHAMFERS AS NEEDED	ALL DIMENSIONS IN MM UNLESS OTHERWISE STATED 			 MANUFACTURER FROM CHINA	
NOTICE. DIMENSIONS ARE FOR REFERENCE ONLY	IF IN DOUBT -ASK	Name	DATE	TITLE	CATALOG OF CLZ OPTICAL DOMES 65MM DIA, 3MM THICK, UNCOATED H-K9L DOME
	TOLERANCE (UNLESS OTHERWISE STATED)	DESIGN	Royan Luo		
FOR INFORMATION ONLY: DO NOT MANUFACTURE PARTS TO THIS DRAWING	.X ± FRACTION ± 	CHECKED	Bonnie He	9/18/2024	SIZE
	.XX ± ANGLE ±	POS			
	.XXX ± GENERAL ±	ENG APPR			DWG NO
		MFG APPR			
					CLZ-DOME-65