

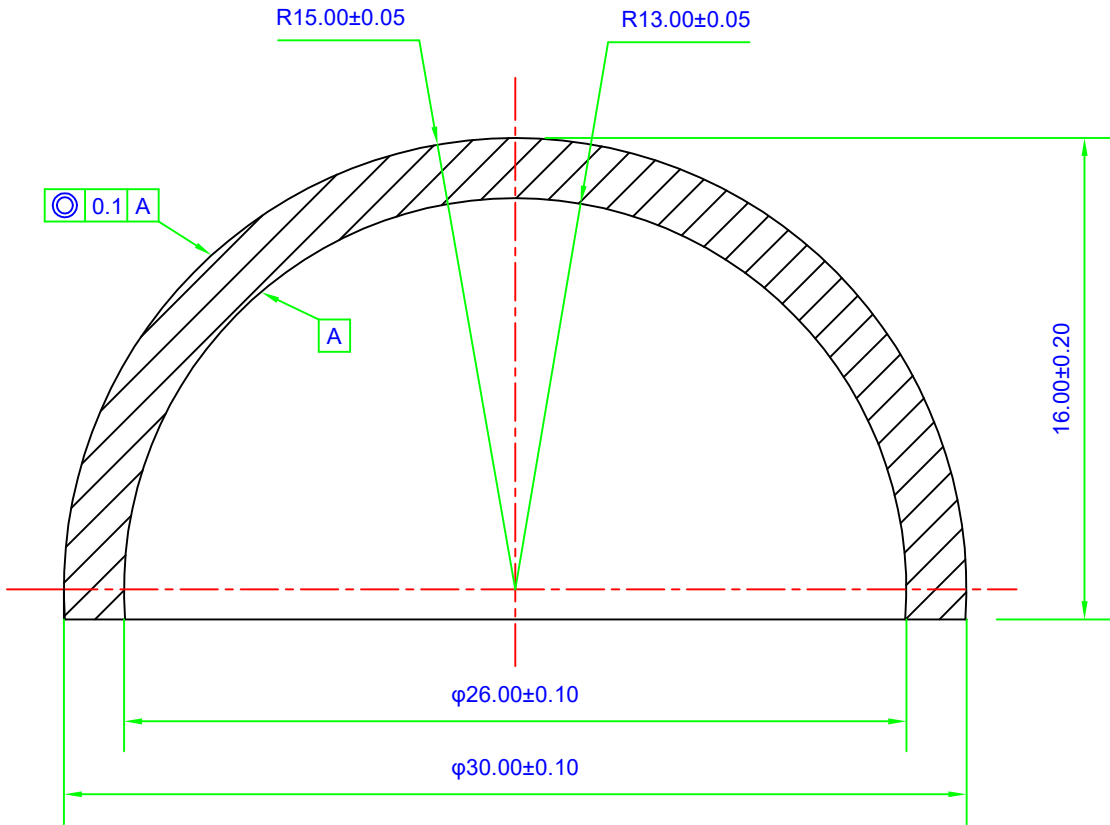





REVISIONS			
LTR	ECD	DATE	APPROVED

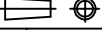

SURFACE 1	MATERIAL	SURFACE 2
R = 15.00 ± 0.05mm 3/ 10(5)  4/  5/ 60-40 Chamfer: 0.2-0.5mm × 45°	H-K9L (CDGM) nd= 1.51680 vd= 64.20 0/ 1/ 2/ 6/	R = 13.00 ± 0.05mm 3/ 10(5)  4/  5/ 60-40 Chamfer: 0.2-0.5mm × 45°

PROTECTIVE CHAMFERS AS NEEDED	ALL DIMENSIONS IN MM UNLESS OTHERWISE STATED 			 <small>MANUFACTURER FROM CHINA</small>	
NOTICE. DIMENSIONS ARE FOR REFERENCE ONLY	IF IN DOUBT -ASK	DESIGN	Name	DATE	TITLE CATALOG OF CLZ OPTICAL DOMES 30mm DIA, 2mm THICK, UNCOATED H-K9L DOME SIZE A4 DWG NO CLZ-DOME-30D
FOR INFORMATION ONLY: DO NOT MANUFACTURE PARTS TO THIS DRAWING	TOLERANCE (UNLESS OTHERWISE STATED)	CHECKED	Sally Song	6/05/2019	
	.X ± FRACTION ± 	POS			
	.XX ± ANGLE ±	ENG APPR			
	.XXX ± GENERAL ±	MFG APPR			