

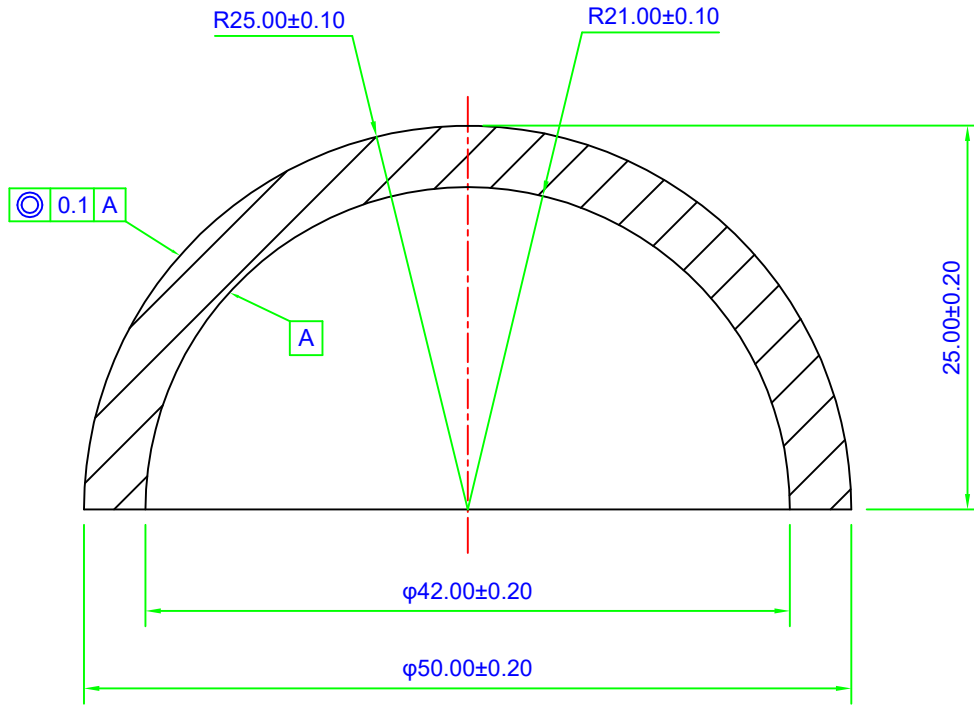





REVISIONS			
LTR	ECD	DATE	APPROVED

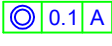

SURFACE 1	MATERIAL	SURFACE 2
R = 25.00 ± 0.10 mm 3/ 10(5)  4/  0.1 A 5/ 60-40 Chamfer: 0.2-0.5mm $\times 45^\circ$	H-K9L (CDGM) nd=1.51680 vd=64.20 0/ 1/ 2/ 6/	R = 21.00 ± 0.10 mm 3/ 10(5)  4/  A 5/ 60-40 Chamfer: 0.2-0.5mm $\times 45^\circ$

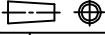
PROTECTIVE CHAMFERS AS NEEDED	ALL DIMENSIONS IN MM UNLESS OTHERWISE STATED 				 <small>MANUFACTURER FROM CHINA</small>
	IF IN DOUBT -ASK	Name	DATE		
NOTICE: DIMENSIONS ARE FOR REFERENCE ONLY	TOLERANCE (UNLESS OTHERWISE STATED)	DESIGN	Sally Song	12/05/2024	TITLE
	.X \pm FRACTION \pm 	CHECKED			
FOR INFORMATION ONLY: DO NOT MANUFACTURE PARTS TO THIS DRAWING	.XX \pm ANGLE \pm	POS			SIZE
	.XXX \pm GENERAL \pm	ENG APPR			A4
		MFG APPR			DWG NO
					CLZ-DOME-50D